

# Picnik

© Design by Dirk Wynants & Xavier Lust for Extremis, 2002

extremis®



## Dimensions

The Picnik is available in 1 dimension

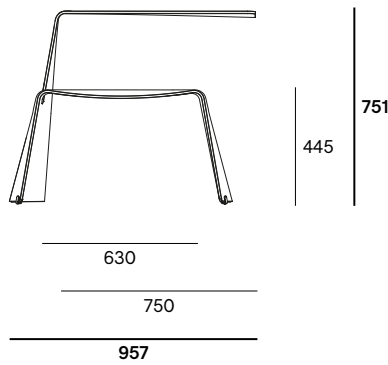
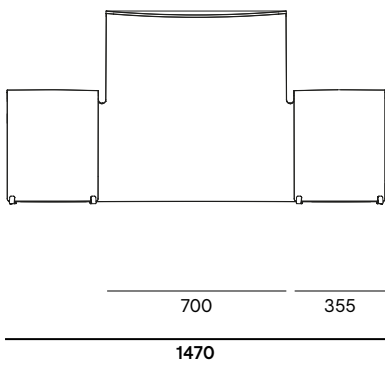
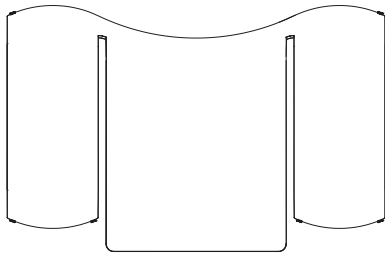

## Box dimensions

The Picnik comes in 1 box

Box 1: Picnik

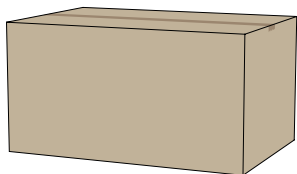

Box dimensions (mm)		L	W	H	Qty	Volume (m <sup>3</sup> )	Gross weight (kg)	Net weight (kg)	Packaging weight (kg)
Picnik	Box 1	1500	1000	800	1	1,20	73,70	60,00	13,70

# Wheelchair accessibility dimensions

---

As specifications for wheelchair accessibility vary around the world, please review the dimensions below to ensure the measurements of each solution meet the specifications of your local requirements

Accessible on the open side of the tabletop

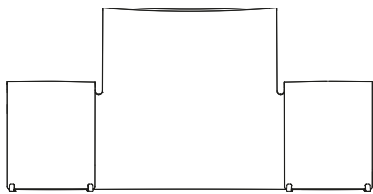
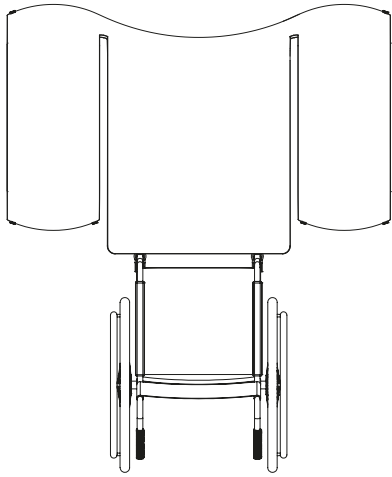

761

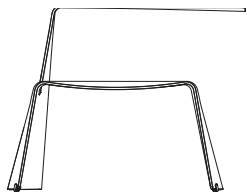

721

# Materials & colors

Check price list or [www.extremis.com](http://www.extremis.com) for current materials & colors

## Picnik



Off white (RAL9002)  
Structured powder coating



Verdigris  
Structured powder coating



Copper brown (RAL8004)  
Structured powder coating



Cobalt blue (RAL5013)  
Structured powder coating



Sun yellow (RAL1032)  
Structured powder coating



Pistache (RAL6021)  
Structured powder coating



Materials	Key facts	Thickness	Layer thickness	Density	In/outdoor	Water	UV color fastness	Flame retarding
		mm	micron					
Structured powder-coated aluminium	<ul style="list-style-type: none"> <li>A technique of applying dry paint to a part</li> <li>Electrostatically charged and sprayed onto the object</li> <li>Placed in an oven and powder particles melt and coalesce to form a continuous film</li> <li>More scratch-resistant than non structured powder-coating</li> </ul>	10	50 - 100	2,70 10 <sup>3</sup> kg/m <sup>3</sup>	Outdoor & indoor	n.a.	Very good: color can fade to some extent when exposed to UV	NEN-EN 13501-1 A2-s1*

### NEN-EN13501-1 A2-s1

Satisfying the same criteria as class B for the SBI-test according to EN 13823. In addition, under conditions of a fully developed fire these products will not significantly contribute to the fire load and fire growth

# Warranty

Our quality promise, made solid. Material based warranty.

Each material has unique properties, and the warranty covers issues specific to each. Steel should not rust, coatings should not peel, and wood should not rot. We have outlined the warranty coverage for all materials in our Warranty Chart for your convenience.

Based on our 30 years of expertise with wood, fabrics and metals, we now offer 5 to 15 years warranty.

	<p><b>GALVANIZED STEEL</b>          Enjoy an impressive 15-year warranty on all galvanized steel parts. We proudly use this exceptional Cradle to Cradle certified technique to protect steel from rusting, incorporating it into nearly all our designs.</p>
	<p><b>COATED METALS, STAINLESS STEEL, WOOD AND SUNBRELLA</b>          We offer a comprehensive 5-year warranty on all powder coated metal parts, stainless steel components, wooden parts, and Sunbrella fabrics. This extension ensures that all key materials of our products are covered</p>

						
	Galvanized steel	Stainless steel	Coated metals	Wood species	Sunbrella fabrics	Other materials
Structural — Functional	<b>15 years</b>	<b>5 years</b>	<b>5 years</b>	<b>5 years</b>	<b>5 years</b>	<b>2 years</b>
Rust	<b>15 years</b>	<b>5 years</b>	<b>5 years</b>			
Wood rot				<b>5 years</b>		
Cracks				<b>5 years</b> for cracks > 4 mm		
Terms apply: Please read our commercial warranty statement <a href="#">here</a>						

## Good to know

- Also a miniature version of this iconic piece available.
- Stackable up to 5 pieces and protect with blankets.
- Picnik is cut out of one aluminium sheet without any loss of material.

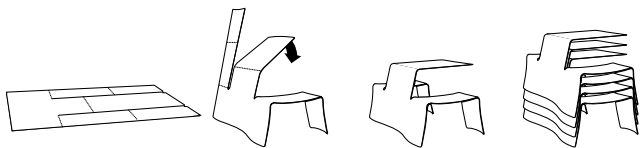

## Maintenance

[www.extremis.com/maintenance](http://www.extremis.com/maintenance)

### POWDER COATED PARTS

- Use Extremis multi cleaner, a 100% biodegradable detergent or common kitchen cleaning products. Avoid using aggressive products. These surfaces are best cleaned with a neutral cleaning product diluted in water.

## Floor fastening

Picnik comes with an optional floor fastening set: four stainless steel feet to be fixed with bolts. Use suitable bolts or screws from a specialized store depending on the material your terrace is made of.



## F.A.Q.

*Q: Is it possible to stack the table?*

*A: It is possible, but as it is quite heavy, it is not so often done. To avoid damage, we recommend using blankets.*

*Q: Is it easy to move the table?*

*A: With two people this is very doable.*

## Protective feet

Picnik comes with optional protective feet for delicate floor: four stainless steel feet with felt.



## Warnings

### General

- Do not use any sharp tools to open the packaging.
- We strongly advise against using power tools.
- Tripping hazard, mind your step.
- Do not put out cigarettes on the table.
- Not graffiti proof.
- Do not leave children unattended whilst playing on the table.
- To avoid danger of suffocation, keep plastic bags away from babies and children.
- Colors can differ over years and from batch to batch.

### Product

- Do not drag the table, but carry it with minimum 2 people.

- Anchoring the product has to be done by qualified people.
- For anchoring: use suitable bolts or screws from a specialized store depending on the material your terrace is made of.
- There are protective feet for indoor use.
- Stackable up to 5 pieces and protect with blankets.
- Always stack the table with 2 people.
- The Picnik tabletop can bear a maximum load of 120 kg.
- Max. 2 people or 160 kg per bench.

### Powder coating

- White powder coating requires more maintenance.
- Do not use abrasive scouring powders or scourers as they will scratch the surface.

- Color can fade to some extent when exposed to UV.
- Flame retarding - NEN-EN13501-1 A2-sl - Satisfying the same criteria as Class B for the SBI-test according to EN13823. In addition, under conditions of a fully developed fire these products will not significantly contribute to the fire load and fire growth.
- Dark colors can get very hot in sunny weather.

The content of this document, in particular the mentioned models, is protected by copyrights and/or design rights. The present document and its content is communicated to you for information purposes only. Any partial or total reproduction or any other use without our prior written permission is strictly prohibited. This technical sheet remains subject to possible changes. All dimensions are in **mm**, unless mentioned otherwise. Extremis is not responsible for the errors in the documentation of products. All measurements are approximate and are provided for informational purposes only.

**Tech  
sheet**  
20250519